



INSTRUCTIONS D'ASSEMBLAGE
ASSEMBLY INSTRUCTIONS

MONARCH
SPECIALTIES INC.

I 2506

MEUBLE TV -
36"L / METAL NOIR ET VERRE TREMPE NOIR

TV STAND -
36"L / BLACK METAL WITH TEMPERED BLACK
GLASS







POUR DE L'ASSISTANCE OU POUR COMMANDER
DES PIÈCES CONTACTEZ NOTRE DÉPARTEMENT
DE SERVICE À LA CLIENTÈLE.

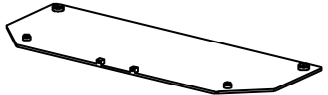

FOR ASSISTANCE OR TO ORDER PARTS
CONTACT OUR CUSTOMER SERVICE DEPARTMENT

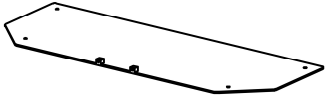
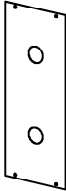
WWW.MONARCHSERVICE.COM

LISTE DES PIÈCES
PARTS LIST

PIÈCE / PART #	IMAGE	DESCRIPTION	QTY / QTÉ
1		GLASS TOP SURFACE EN VERRE	1
2		GLASS SHELF ÉTAGÈRE EN VERRE	1
3		GLASS SHELF ÉTAGÈRE EN VERRE	1
4		BACK PANEL PANNEAU ARRIÈRE	1
5		SUPPORT BAR BARRE DE SOUTIEN	4

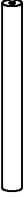
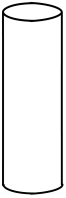
LISTE DES PIÈCES
PARTS LIST

PIÈCE / PART #	IMAGE	DESCRIPTION	QTY / QTÉ
6		SUPPORT BAR BARRE DE SOUTIEN	4
7		LEG PATTE	2
8		LEG PATTE	2

LISTE DES PIÈCES DE MONTAGE
HARDWARE LIST

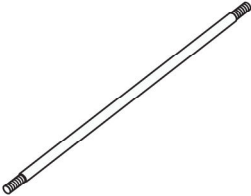
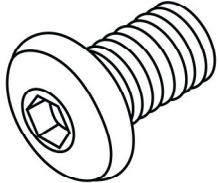
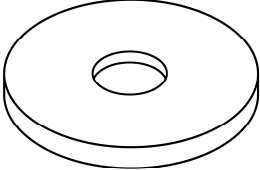
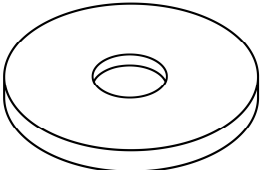
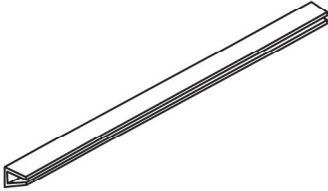
PIÈCE / PART #	IMAGE	DESCRIPTION	QTY / QTÉ
A		<p align="center">THREADED ROD - 20 5/8"</p> <p align="center">TIGE FILETÉE - 20 5/8"</p>	4
B		<p align="center">ASSEMBLING BOLT - Ø 1/4" X 3/8"</p> <p align="center">BOULON D'ASSEMBLAGE - Ø 1/4" X 3/8"</p>	4
C		<p align="center">PLASTIC WASHER - Ø 1 1/2"</p> <p align="center">RONDELLE DE PLASTIQUE - Ø 1 1/2"</p>	8
D		<p align="center">PLASTIC WASHER - Ø 1"</p> <p align="center">RONDELLE DE PLASTIQUE - Ø 1"</p>	8
E		<p align="center">RUBBER</p> <p align="center">CAOUTCHOUC</p>	2

LISTE DES PIÈCES DE MONTAGE
HARDWARE LIST

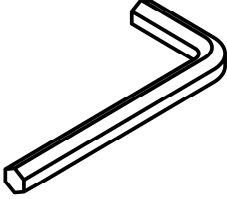
PIÈCE / PART #	IMAGE	DESCRIPTION	QTY / QTÉ
F		HEX KEY CLÉ HEXAGONALE	1



OUTIL DE VÉRIFICATION DE DIMENSIONS DES PIÈCES
HARDWARE DIMENSIONS VERIFICATION TOOL



ÉTAPE / STEP 1

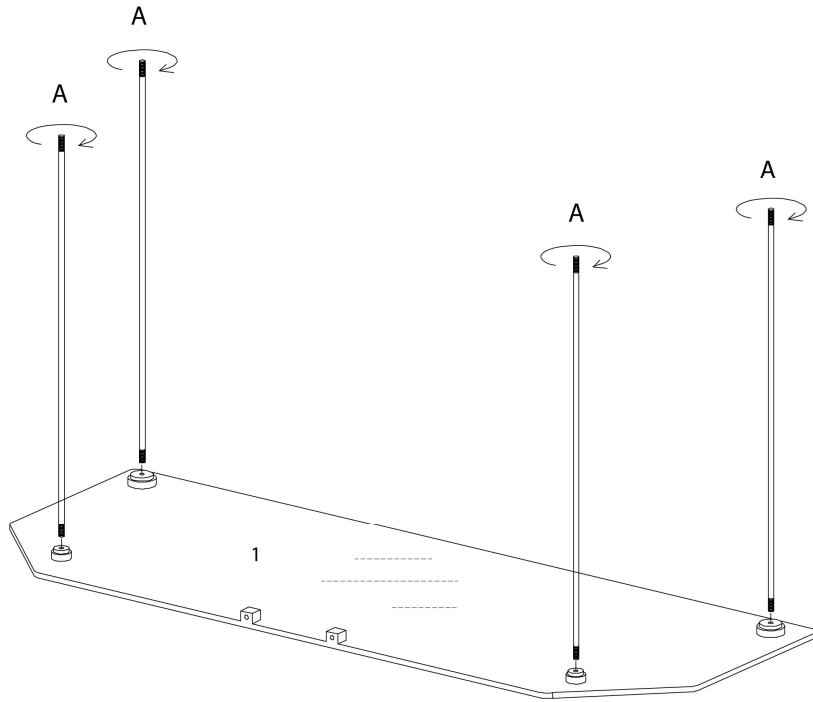

ÉTAPE / STEP 2

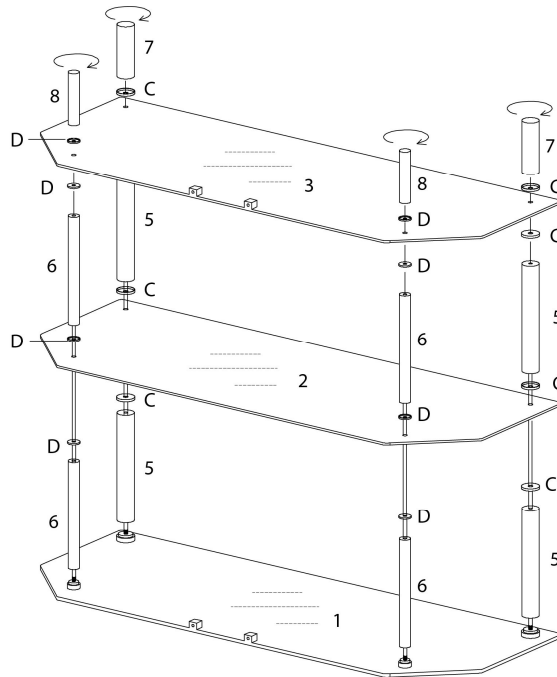

ÉTAPE / STEP 3

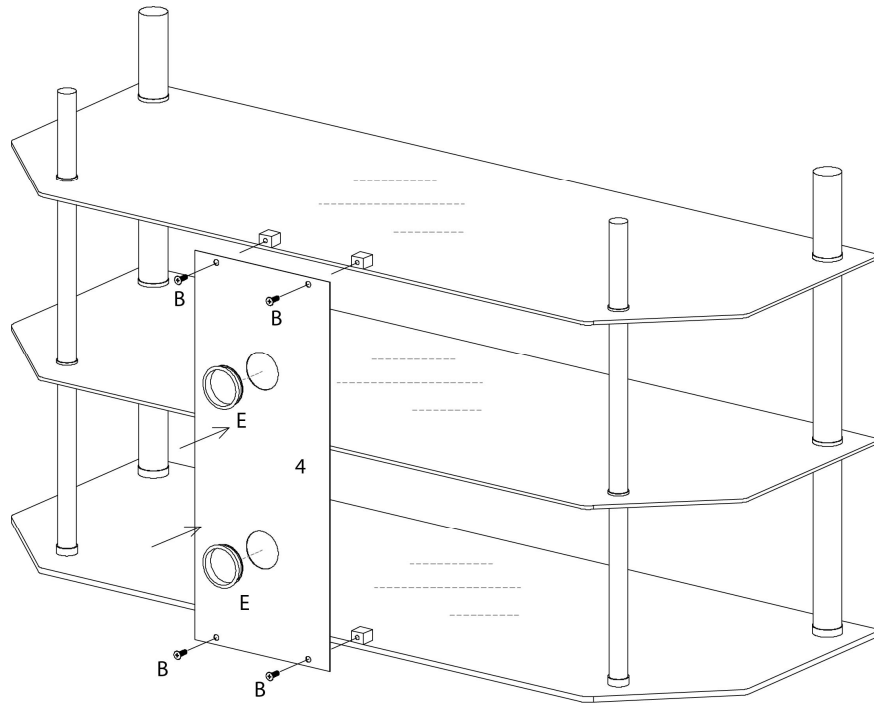

ÉTAPE / STEP 4

